

# Collaborative Robots

# TM20

## Increased power and versatility for assembly, packaging, inspection, and logistics

- The combined 20 kg payload capacity and 1300 mm reach expands material handling capabilities.
- Easy-to-use graphical programming environment for quick startup and operation.
- Built-in vision-based robot control enables visual serving, inspection, and measurement operations.
- TMvision and Landmark allow truly flexible, fast changeover.
- Plug & Play ecosystem provides the tools and versatility for many manufacturing needs.
- Capability to integrate with mobile robots enables fully autonomous machine tending and logistics handling applications.



## TM20 Ordering Information

Type	Power Source	Integrated Camera	Reach	Fieldbus	Cable Length	Part Number	
TM20	AC	Y	1300 mm	N	3 m	RT6-4001301	
				Y		RT6-4001321	
				N	12 m	RT6-4001302	
		Y		RT6-4001322			
		DC		N	N	3 m	RT6-4011301
					Y		RT6-4011321
	N				12 m	RT6-4011302	
	Y			RT6-4011322			
	Y			1.5 m	N	RT6-4101301	
					Y	RT6-4101321	
		N			RT6-4111301		
				N		RT6-4111321	

## Global Part Number Structure

RT6 - □ □ □ □ □ □ □ □  
 1 2 3 4 5 6 7 8

No.	Item	Specifications	Symbol
(1)		Techman Series	
(2)	Model Type	TM20	4
(3)	Power Source	AC	0
		DC	1
(4)	Integrated Camera	Standard	0
		X Model (no camera)	1
(5)(6)	Arm Length	1300	13
(7)	Option	Standard	0
		Semi	1
		Fieldbus	2
(8)	Cable Length	Standard Length (1.5 m / 3 m)*1	1
		Extended Length (12m)*2	2

\*1 A 1.5 meter cable is standard for DC models and a 3 meter cable is standard for AC models.  
 \*2 A 12 meter cable is available for all AC models.

## Items Included with a TM20 Robot System

Item	Robot	Cable	Robot Stick	Control Box	Calibration Plates	I/O Cables	Landmark	Ground wire	Jumper Wire	Power cable	SEMI Switch	SEMI ESTOP Cable
Description	TM20	3 meter cable for AC unit and 1.5 meter cable for DC unit	Hand control to move robot	Robot Control Box	Large and small. Not with X model robots	1 m	Not with X model robots	3 m	3 cm	For Control Box (3 cable: B, G, F) 1.8 m	SEMI Emergency OFF, SEMI robots only	SEMI robots only, 3 m
Quantity	1	1	1	1	2	2	2	2	2	1	1	1

## Specifications

Product Name		TM20		TM20X	
Power Source		AC	DC	AC	DC
Weight (kg)		33		33	
Controller Weight (kg)		14.1			
Max Payload (kg)		20			
Reach (mm)		1300			
Mounting		Wall, Table, Ceiling			
Average Speed (m/s)		1.3			
Joint Range	Joint 1	±270°		±360°	
	Joint 2, 4, 5	±180°		±360°	
	Joint 3	±166°			
	Joint 6	±270°		±360°	
Joint Speeds	Joint 1, 2	90°/s			
	Joint 3	120°/s			
	Joint 4	150°/s			
	Joint 5	180°/s			
	Joint 6	225°/s			
Repeatability (mm)		±0.1			
Ingress Protection		IP54 (robot arm), IP32 (control box), IP40 (robot stick)			
Cleanroom Class		ISO Class 3			
Operating Temperature and Humidity		0 to 50°C, 85% max. (with no condensation)			
Storage Temperature and Humidity		-20 to 60°C, 75% max. (with no condensation)			
Operating and Storage Environment		No corrosive gases or exposure to water-soluble cutting oil.			
Motor Power Supply		110 to 240 VAC, 50/60 Hz	24 to 60 VDC	110 to 240 VAC, 50/60 Hz	24 to 60 VDC
Robot Arm Cable Length (m)		3 or 12	1.5	3 or 12	1.5
I/O Ports	Control Box	Digital In: 16, Digital Out: 16 Analog In: 2, Analog Out: 1			
	Tool	Digital In: 4, Digital Out: 4 Analog In: 1, Analog Out: 0			
I/O Interface		COM: 3, HDMI: 1, LAN: 3, USB2.0: 4, USB3.0: 2			
Communication		RS232, Ethernet (master), Modbus TCP/RTU (master & slave), PROFINET (optional), EtherNet/IP (optional)			
I/O Power Supply		24 VDC 2.0 A (control box) / 24 VDC 1.5 A (tool)			
Programming Environment		TMflow, flowchart based			
Integrated Camera Available		5 MP, color		None	
SEMI S2 Certified <sup>1</sup> Available		No	Yes	No	No
Fieldbus Available		EtherNet/IP, PROFINET			

\*1 SEMI (Semiconductor Equipment and Materials International) is the central global network of manufacturers of micro and nano electronics that issues safety guidelines. SEMI S2 is the most well-known standard in semiconductor manufacturing equipment for Environmental, Health, and Safety (EHS).

# Dimensions

(Unit: mm)

## TM20/20X

### Workspace Side View

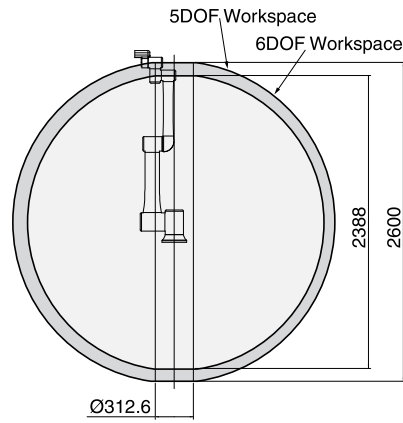
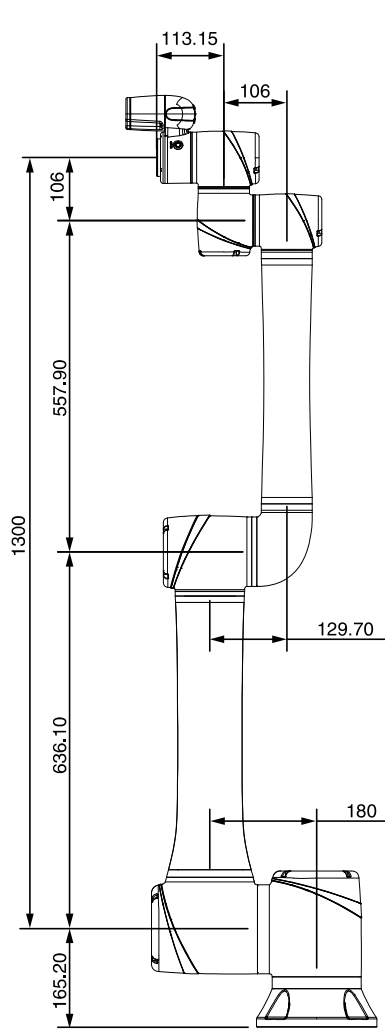

### Footprint

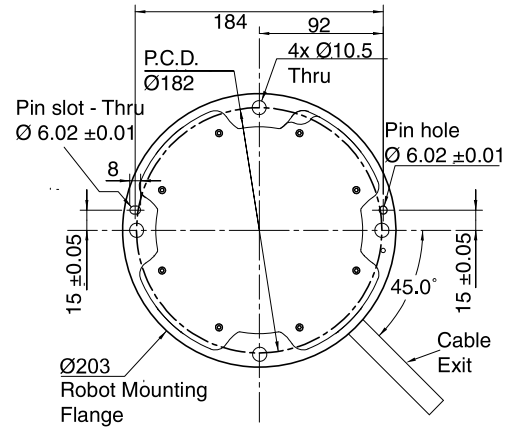

### Flange

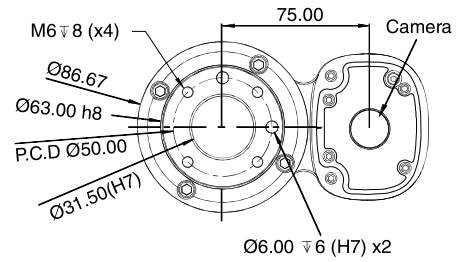
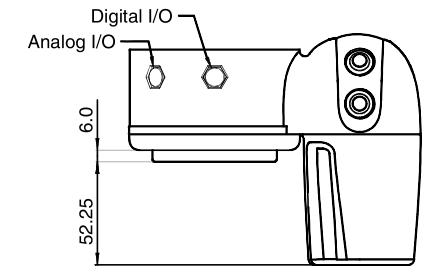



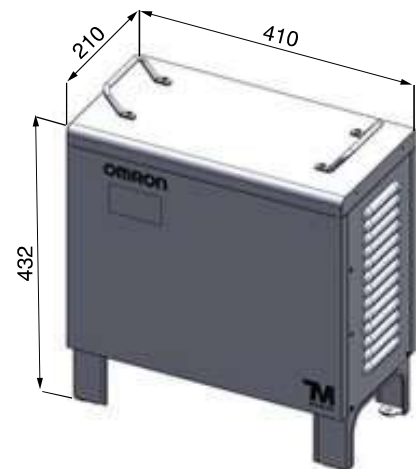







### Control Box



# Accessories & Software

## Accessories

Appearance	Product Name	Description	Remarks	Part Number
	Landmark	Robot positioning tool as a reference to the environment.	Two included with purchase of a robot. Not included with X model robots	RT6-A000021
	Mobile Workstation (MWS)	MWS is a convenient tool for users to mount the robot arm on work surface, and store the control box safely within. Users can easily move the MWS with the robot to different work cells.	Compatible with OMRON TM5 only.	RT6-A000010
	Robot stand	Similar to MWS, the robot stand can be easily moved with the robot to different work stations. EtherNet/IP	Height adjustable. Compatible with OMRON TM5 only.	RT6-A000009
	SSD with cable	128 GB solid state hard drive.	SATA cable included. Recommended for external cameras image logging.	RT6-A000012
	Kit, calibration set with additional pin	Toolkit for teaching a precise tool center point (TCP) that can be used for manual workspace calibration within TMvision.	Required for TCP and manual vision calibration.	RT6-A000002
	Robot stick stand	Mounting fixture for the robot stick.	Can be used on desktops, walls, and MWS.	RT6-A000000
	Pneumatic control box	Controls the inputs and outputs and monitors air pressure for Kilews screw driving applications.	Compatible with Kilews screw driving solution kit only. Recommended to attach to the robot stand.	RT6-A000015
	Polarizer Light Module	Improves the reflection caused by the robot's own light source on the surface of highly reflective objects.	For TM5/12/14/16/20 models with HW 3.2 or above.	RT6-A000022
	Air Filter (ROHS)	Replacement air filter for the control box.	The filter must be changed regularly to maintain efficiency. The replacement procedure can be found in the Hardware Installation Manual.	19936-443F
	Teach Pendant	A handheld operating teach pendant. 10.1 inch WXGA resolution panel.	NexCobot Teach Pendant model TP-100-1.	RT6-A000020

## Software

Product Name	Add-On Product Names	Remarks	Part Number	Add-On Part Numbers
USB Dongle	-	Required for all extra software licenses.	RT6-A000004	-
TMflow	-	Software required to control the cobot. Free download	-	-
	TM Identify & Measure	License, add-on to TMflow. Includes: identification of pose variation, specific color area size, subtract reference image, line/circle burr, counting and gauge.	-	RT6-S100000
	TM External Vision	License, add-on to TMflow. Required when using eye-to-hand cameras.	-	RT6-S100002
	TM OCR	License, add-on to TMflow. Includes: Text OCR and Number OCR.	-	RT6-S100003
	License, OMRON-TM Operator Suite	License, includes 2 USB Dongles (1 for laptop/PC, and 1 for additional IPC)	-	RT6-S100006
	License, OMRON-TM Operator Runtime	License, includes 1 USB Dongles (for additional IPC)	-	RT6-S100007
	License, TMStudio Palletizing Wizard Export	License, includes 1 USB Dongles (for additional IPC)	-	RT6-S100008
	License, OMRON-TM Operator Runtime and Palletizing Wizard Export	License, includes 1 USB Dongles (for additional IPC)	-	RT6-S100009

Product Name	Add-On Product Names	Remarks	Part Number	Add-On Part Numbers
TMflow Editor	-	License, provides a convenient way to open and edit project offline.	RT6-S200001	-
	TMflow Editor - Offline AOI	License, add-on to TMflow Editor. Enables TMflow Editor to offline edit a TMflow project that includes AOI vision.	-	RT6-S100005

### Mobile Work Station (MWS)

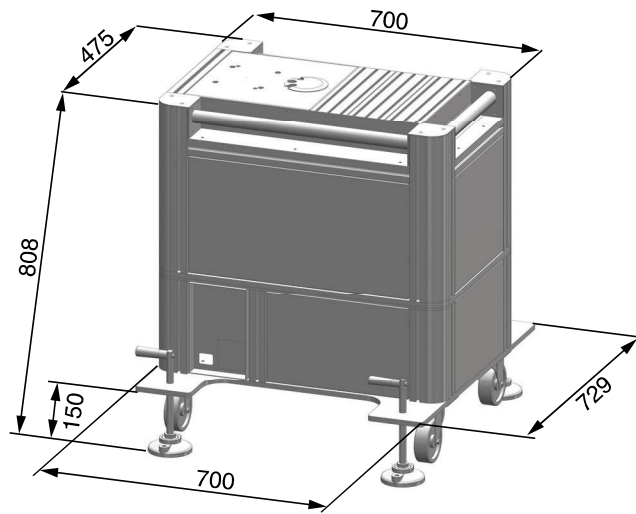

### Robot Stand

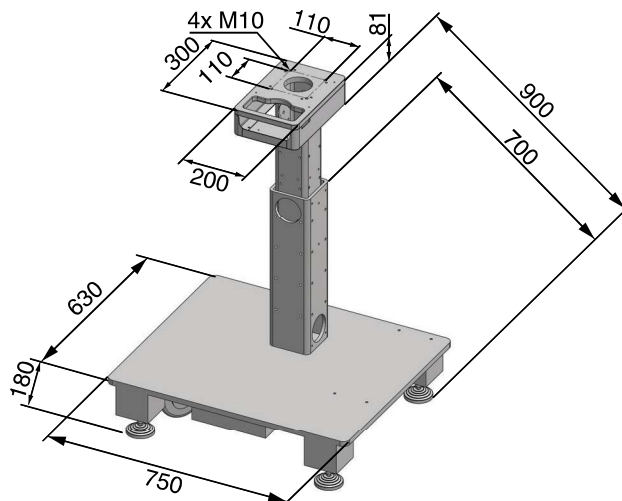



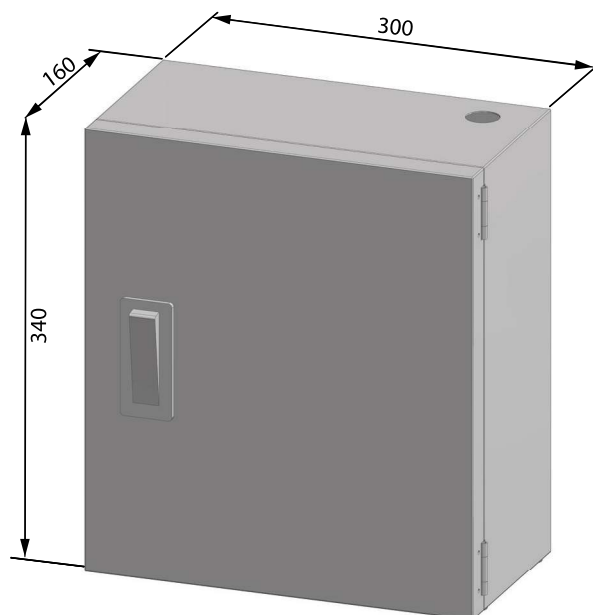







### Pneumatic Control Box























# Recommended Plug & Play Hardware









Category	Appearance	Company	Product Name	Manufacturer SKU Number*	Description	
Grippers		Robotiq	Adaptive Gripper 2-Finger 85/140 for OMRON TM robot	85 kit: AGC-OMRON-KIT-85 140 kit: AGC-OMRON-KIT-140	A 2-finger adaptive gripper that can adapt to parts of various shapes and sizes. Comes in two stroke options – 85 mm and 140 mm. Each kit includes: - End effector coupling kit - 10 m communication cable - RS485 to RS232 converter - RS485 to USB converter - Screw kit - Quick start guide	
			Hand-E gripper for OMRON TM robot	HND-OMRON-KIT	A 2-finger parallel gripper with an IP67 rating. 50 mm stroke. Each kit includes: - Fingertip starting kit - End effector coupling kit - 10 m communication cable - RS485 to RS232 converter - RS485 to USB converter - Screw kit - Quick start guide	
			EPick for OMRON TM robot	VAC-OMRON-EPICK-KIT1	KIT1 includes 1 vacuum cup KIT2 has a suction system for 2 cups KIT4 has a suction system for 4 cups	A vacuum gripper that uses an integrated vacuum generator. Each kit includes: - Basic gripper unit - End effector coupling kit - 10 m communication cable - RS485 to RS232 converter - RS485 to USB converter - Quick start guide - Vacuum cup(s): 1.5 bellows, 55 mm dia.
				VAC-OMRON-EPICK-KIT2		
				VAC-OMRON-EPICK-KIT4		
			AirPick for OMRON TM robot	VAC-OMRON-AIRPICK-KIT1	KIT1 includes 1 vacuum cup KIT2 has a suction system for 2 cups KIT4 has a suction system for 4 cups	A vacuum gripper that uses an external pneumatic supply. Each kit includes: - Basic gripper unit - Tubing 8 mm x 8 m - End effector coupling kit - RS485 to RS232 converter - RS485 to USB converter - Quick start guide - Vacuum cup(s): 1.5 bellows, 55 mm dia.
				VAC-OMRON-AIRPICK-KIT2		
				VAC-OMRON-AIRPICK-KIT4		
			I/O Coupling	IO-CPL-OMRON-KIT	Component that connects the Robotiq adaptive/vacuum gripper to the wrist of the OMRON TM robot to eliminate the need for an external serial communication cable. Each kit includes: - I/O Coupling - Screw kit - Micro-USB to USB cable - 16G USB Stick	
			Dual-Grip Adapter Plate	AGC-APL-159-002	Adapter plate and mounting screws to mount two grippers onto the OMRON TM robot.	
			2F-85 Dual kit for OMRON Robots 2F-140 Dual kit for OMRON Robots HAND-E Dual kit for OMRON Robots	OMRON-DUAL-AGC-85 OMRON-DUAL-AGC-140 OMRON-DUAL-HND	Kit that enables dual gripper setting. Each kit includes: - Chosen gripper x 2 - Mechanical coupling x 2 - USB to RS485 Adapter - Communication Cable - M12 5 Pins Splitter - Dual-Grip Adapter Plate - Screw kit x 2	
		OnRobot	RG2 Gripper	102012	Electric 2-finger gripper. Each kit includes: - RG2 Gripper - Fingertip adapters (pre-mounted) - Integrated Quick OnRobot Changer (tool side) - Torx key	



Category	Appearance	Company	Product Name	Manufacturer SKU Number*	Description
Grippers		OnRobot	RG2-FT	102075	<p>The RG2-FT has 2 force/torque sensors and 2 time-of-flight-based proximity sensors integrated in the fingertips. It is a state of the art gripper with added sensing and intelligence, capable of controlling the robot and itself to achieve what the operator would like it to do, even when the exact parameters cannot be programmed in advance. It includes:</p> <ul style="list-style-type: none"> <li>- RG2-FT Gripper</li> <li>- Fingertip adapter (pre-mounted)</li> <li>- Cable</li> <li>- Cable holder and screws</li> </ul> <p>Required for mounting on the robot:</p> <ul style="list-style-type: none"> <li>- single Quick OnRobot Changer (robot side)</li> <li>- dual Quick OnRobot Changer (robot side)</li> <li>- HEX QC</li> </ul> <p>Required for connecting to the robot:</p> <ul style="list-style-type: none"> <li>- connection kit with compute box</li> </ul>
			RG6 Gripper	102021	<p>Electric 2-finger gripper with larger stroke. Each kit includes:</p> <ul style="list-style-type: none"> <li>- RG2 Gripper</li> <li>- Fingertip adapters (pre-mounted)</li> <li>- Integrated Quick OnRobot Changer (tool side)</li> <li>- Torx key</li> </ul>
			VG10 Electric Vacuum Gripper	101661	<p>Flexible and adjustable electrical vacuum gripper. Each kit includes:</p> <ul style="list-style-type: none"> <li>- VG10 Gripper</li> <li>- 30 mm dia. suction cups x 16 (pre-mounted)</li> <li>- Integrated Quick OnRobot Changer (tool side)</li> <li>- 40 mm dia. suction cups x 4</li> <li>- 15 mm dia. suction cups x 4</li> <li>- Blind screws x16</li> <li>- Positioning arrows</li> <li>- Torx key</li> </ul>
			Single Pad Gecko	104086 SP1 104087 SP3 104088 SP5	<p>Compact, lightweight Gecko Single Pad Gripper requires no cables, electricity, air or programming. The Gecko SP is available in 3 sizes; SP1, SP3, and SP5 named after the gripper payload in kilos, featuring the ability to lift a wide range of flat, smooth, shiny or perforated surfaces. Options are:</p> <ul style="list-style-type: none"> <li>- Gecko SP1 (with 35 mm pad)</li> <li>- Gecko SP3 (with 60 mm pad)</li> <li>- Gecko SP5 (with 75 mm pad)</li> </ul>
			OMRON TM Robot Kit	102359	<p>This kit must be purchased for the use of OnRobot grippers on OMRON TM collaborative robot. Each kit includes:</p> <ul style="list-style-type: none"> <li>- Compute Box</li> <li>- Power supply</li> <li>- Adapter plate (included in all kits but only necessary for VG10 and Gecko grippers)</li> <li>- USB stick with software components and User Manual</li> <li>- Device cable 5 m</li> <li>- UTP cable 0.5 m</li> <li>- I/O cable 0.3 m</li> <li>- Cable management hook/loop</li> </ul>
			3FG15-3 Finger Gripper	103666	<p>The 3FG15 is ideal for gripping a wide range of cylindrical objects in machine-tending applications such as CNC lathe machines. The gripper design automatically centers workpieces, with payload up to 15 kg. It includes:</p> <ul style="list-style-type: none"> <li>- 3FG15</li> <li>- Torx Key T20</li> <li>- 3 x Steel Fingertip 13 dia.</li> <li>- 3 x Rubber Fingertip 16.5 dia.</li> </ul>
			Soft Gripper	103546 SG Base Part 103689 SG-a-H 103860 SG-a-S 103691 SG-b-H	<p>This is available with three interchangeable silicon-molded cups to handle a wide array of irregular shapes and delicate items, making it ideal for pick-and-place applications in food and beverage and other "clean" production applications. The silicon cups are dishwasher-safe and comply with FDA 21 CFR (for non-fatty items) and EC 1935/2004 for food handling. Maximum payload of 2.2 kg, and grip dimensions range from 11 mm to 118 mm, depending on cup used.</p>
			F2G7 Parallel Gripper	106376	<p>This parallel gripper is used for tight spaces and demanding payloads. Ready for use almost anywhere, with IP67 rating for harsh environments and ISO Class 5 certification for cleanroom use.</p>
			MG10 Magnet Gripper	105202	<p>This versatile electric magnetic gripper is used for safe and precise collaborative applications. Built-in intelligence with easily adjustable force and part detection ensures reliable handling of a wide range of part sizes and weights.</p>
			VGC10	102844	<p>This flexible electric vacuum gripper has changeable suction cup options for unlimited customization possibilities. It's smaller and half the weight of VG10 but with the same payload. It includes:</p> <ul style="list-style-type: none"> <li>- 40 mm dia. Vacuum Cups</li> <li>- 30 mm dia. Vacuum Cups</li> <li>- 15 mm dia. Vacuum Cups</li> <li>- Fittings</li> <li>- Push-in fittings</li> <li>- M6 x 10 mm Screws</li> <li>- Blind Screws</li> <li>- Torx T30</li> <li>- 3 mm hex keys</li> <li>- Adapter Plate</li> <li>- Extension pipe 50 mm</li> </ul>



Category	Appearance	Company	Product Name	Manufacturer SKU Number*	Description
Grippers			VGP20 Vacuum Gripper	107242 107567	This powerful electric vacuum gripper is ideal for cardboard box palletizing. Built-in intelligence and multichannel functionality ensures failsafe, flexible operation. The following attachment is required to prevent mechanical interference with camera module: - VGP20 Extender 50 mm
		Schmalz	ROB-SET ECBPi OMRON	10.03.01.00544	Complete vacuum gripper for collaborative robots. Each kit includes: - Vacuum generator (ECBPi) - End-effector coupling kit - Connection cable - Mounting flange - Flat suction cup - Bellows suction cup - Bolts and t-nuts - Operating instructions
			ROB-SET FXCB OMRON	10.01.43.00120	Area gripper equipped with integrated pneumatic vacuum generation. (Needs external air supply.) Each kit includes: - Pneumatic area gripper (FXCB) - Connection cable - Mounting flange - Bolts and t-nuts - Operating instructions
		Schunk	Co-act EGP-C 40-N-N-TMID Co-act EGP-C 40-N-N-TMEK Co-act EGP-C 64-N-N-TMEK	1374363 1375931 1400578	Electric 2-finger parallel gripper certified for collaborative operation. Actuation and communication via 24 VDC and digital I/O. Each kit includes: - Co-act EGP-C gripper - Assembly and Operating Manual - Accessory pack
			Co-act AUB EGP 40/12 Co-act AUB EGP 40/24 AUB Co-act EGP 64/20 AUB Co-act EGP 64/40	1401285 1401286 1401294 1401297	Gripping fingers for Co-act EGP-C.
		SMC	Air Gripper	JMHZ2X7400B-TM	Air gripper equipped with a high precision linear guide. Compact, lightweight product with high gripping force due to air operation. Operate by simply connecting one air supply tube and an electrical wiring M8 connector. Each kit includes: - Air gripper unit - Parallel pin (6 x 10 mm) x 1 - Hexagon socket head cap screw (M6 x 23) x 4 - Protective cover x 1 set (valve side, S.W side) - Hexagon socket head cap screw (M4x10) x 4 - Tube for piping (TU0425BU) 2 m - User manual
			Vacuum Gripper	ZXP-X1	Operate by simply connecting one compressed air supply tube and an electrical wiring M8 connector. The wide variety of SMC suction cup variations can apply to a wide range of picking applications. The adsorbing detection is made easy with sensor signals. Each kit includes: - Vacuum gripper unit - Robot mounting flange - 6 x 10, parallel pin - 8 pcs x M6 x 10, Hexagon socket head cap screw - 2 m, Polyurethane tube: TU0604 - Plug 4 pcs (cup mounting flange) - 4 pcs x suction cup with adapter (suction cup)
		CKD	Compact Gripper RLSH-TM	RLSH-A20D1N-L1-FY2-TM	Small, lightweight, pneumatic gripper with high gripping force. Easy installation with a dedicated common flange and tool-less replacement with a clamp ring, and teaching support is supported with the dedicated software "Pneumatic Gripper." Equipped with an edgeless resin cover and an LED indicator lamp that is visible 360°, it is designed with consideration for safety and supports the introduction of collaborative robots by all customers.
			Long Stroke Gripper RHLF-TM	RHLF-16CS-FY2-TM	
	3-way Finger Gripper RCKL-TM		RCKL-16CS-FY3-TM		

Category	Appearance	Company	Product Name	Manufacturer SKU Number*	Description
Tool Changers		KOSMEK	Robotic Tool Changer	Master Cylinder: SWR0070-M□-□ SWR0120-M□-□ Conversion Plate Set: SWRZ0070-MF4 SWRZ0120-MF4 Tool Adapter: SWR0070-T- □ SWR0120-T-□	High-precision robotic tool changer with many features enables multiple functions of robots and setup time reduction. It enhances the productivity of the automated production line.
			Manual Robotic Hand Changer	Master Cylinder SXR0030-M; Adapter Plate SXRZ0030-MF4; Tool Adapter SXR0030-TF4	Manual Robotic Hand Changer enables quick, intuitive change of robotic tools. Technical knowledge is not required -- operators with diverse skills levels can easily use the Manual Robotic Hand Changer. Adapter Plate includes: - Parallel Pin dia. 5x8 - Parallel Pin dia. 6x12 - 4 Hexagonal Socket Low Head Cap Screws (M6x1x10) - 4 Hexagonal Socket Head Cap Screws (M5x0.8x14)
		OnRobot	Quick OnRobot Changer Robot side 4.5 A	104277	Manual tool changer to attach on the robot's end-of-arm. Either the Quick OnRobot Changer (robot side) or the Dual Quick OnRobot Changer must be purchased for use of all OnRobot grippers. Each kit includes: - Quick OnRobot Changer robot side - Screws - Torx key
			Quick OnRobot Changer - Tool side	102014	Manual tool changer to attach on the tool side. (All OnRobot grippers have this component integrated, so this is only necessary when user is developing their own tool.)
			Quick OnRobot Changer Kit 4.5 A	105925	Each kit includes: - Quick OnRobot Changer (robot side) x 1 - Quick OnRobot Changer (tool side) x 2 - Torx key - Screws and pins
			Dual Quick OnRobot Changer 4,5A	104293	Manual tool changer to attach on the robot's end-of-arm for dual gripper configuration. Either the Quick OnRobot Changer (robot side) or the Dual Quick OnRobot Changer must be purchased for use of all OnRobot grippers. Each kit includes: - Dual Quick OnRobot Changer - Screws - Torx key
3D Bin Picking		Pick-it	Pick-it M	PI-M-2.0	Plug & Play 3D camera and software for picking objects sized 50x50x10 mm or larger. Each kit includes: - Pre-calibrated 3D camera - Pick-it software - Industrial processor - 3G dongle to connect directly to Pick-it support - Calibration plate and ROI box teaching markers - All connection cables (plug & play) - Quick start guide
			Pick-it M-HD	PI-M-HD	Plug & Play 3D camera and software for picking objects sized 10x10x5mm or larger. Each kit includes: - Pre-calibrated 3D camera - Pick-it software - Industrial processor - 3G dongle to connect directly to Pick-it support - Calibration plate and ROI box teaching markers - All connection cables (plug & play) - Quick start guide
Screw Driving		Kilews	Screw Driving Solution Kit	-	Kilews screwdriver kit and pneumatic control box. Each kit includes: - Screwdriver SKD-BN512LM - Power Controller SKP-32BC-60W - Flange E31700-3 - Air Nozzle KD-TM-B500 - Signal box - Pneumatic control box - Installation guide
		OnRobot	Screwdriver	103961 105121 104363 104374 105870	Smart screwdriver with screw feeder easily automates multiple screw driving processes with no downtime for manual changeovers. Precise torque control and intelligent error detection ensure quality and consistency. The following accessories are required depending on the screw size. - Screwdriver Accessory Kit Metric: Screwdriver bits system for various screw types and sizes - Screw Feeder M1-6: Automatic feeder for M1 to 6 size screws - Screw Feeder M2-6: Automatic feeder for M2 to 6 size screws - Angle Bracket

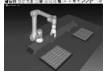
Category	Appearance	Company	Product Name	Manufacturer SKU Number*	Description				
Vision		Basler	GigE camera, color, 5 MP, CMOS 2/3 inch, 23 fps	acA2440-20gc, Global Shutter	External camera for eye-to-hand robot applications. Maximum 2 external cameras per robot.				
			GigE camera, mono, 5 MP, CMOS 2/3 inch, 23 fps	acA2440-20gm, Global Shutter					
			GigE camera, color, 10 MP, CMOS 1/2.3 inch, 10 fps	acA3800-10gc, Rolling Shutter					
			GigE camera, mono, 10 MP, CMOS 1/2.3 inch, 10 fps	acA3800-10gm, Rolling Shutter					
			GigE camera, color, 12.2 MP, CMOS 1/1.7 inch, 8 fps	acA4024-8gc, Rolling Shutter					
		Basler	GigE camera, mono, 12.2 MP, CMOS 1/1.7 inch, 8 fps	acA4024-8gm, Rolling Shutter	External camera for eye-to-hand robot applications. Maximum 2 external cameras per robot.				
			GigE camera, color, 5 MP, CMOS 1/2.5 inch, 14 fps	acA2500-14gc, Rolling Shutter					
			GigE camera, mono, 5 MP, CMOS 1/2.5 inch, 14 fps	acA2500-14gm, Rolling Shutter					
			GigE camera, color, 5 MP, CMOS 1 inch, 21 fps	acA2500-20gc, Global Shutter					
	Force Sensor		ATI	Axia80	9105-TM-Axia80	Six-axis force/torque sensor with EtherCAT communication. Each kit includes: - Interface plate - Power and Ethernet cable - Digital delivery of calibration documents and user manual			
						Robotiq	FT-300	FTS-300-OMRON-KIT	Six-axis force/torque sensor with RS485 Serial Communication. Each kit includes: - Coupling - RS485 to RS232 converter - Power and communication cable with USB adapter - Screw kit
									
		Ewellix	LIFTKIT	LIFTKIT-OM-601	A ready-to-install system that includes a telescopic column with a mounting interface and controller. Stroke options (mm): 500, 600, 700, 800, 900. Each kit includes: - Telescopic pillar - Controller - TM attachment plate - Bottom fixation plate - Handswitch - Cables and screws				
						ADLINK	EtherCAT I/O Expansion Modules KIT	EPS - 9905+6000+203 2+1132	A Kit that includes: chassis w/ EtherCAT ports and voltage input, 32-channel digital output module, 32-channel digital input module.
							EtherCAT I/O Expansion Modules (DO Module)	EPS-2032	32-channel digital output module.
							EtherCAT I/O Expansion Modules (DI Module)	EPS-1132	32-channel digital input module.
						Advantech	Serial Device Server EKI-1524-CE	EKI-1524-CE	External device with serial ports that communicates with the robot via TCP/IP.
Modbus to PROFINET Gateways		EKI-1242IPNMS	A gateway to transform OMRON TM cobot's Modbus to PROFINET, whereby OMRON TM cobot as slave could communicate with PROFINET master devices.						

Category	Appearance	Company	Product Name	Manufacturer SKU Number*	Description
Cable Management		Murrplastik	FHS-C-SET TM5 (TM5-700 & TM5-900)	83693500	Cable management dress pack. Each kit includes: - Conduit (Cable routing hose, Length:2 m, Interior dia.: ~21 mm)
			FHS-C-SET TM12 / TM14 (TM12 & TM14)	83693501	- 4 x Attachment straps - 2 x End plugs - Cable insertion tool - Installation instructions
	FHS-RS-SET TM5 (TM5-700 & TM5-900)		83693506	Cable management dress pack. Each kit includes: - Conduit (Cable routing hose, Length:2 m, Interior dia.: ~21 mm)	
	FHS-RS-SET TM12 / TM14 (TM12 & TM14)		83693507	- 2 x Conduit clamps - Self-retracting hose guide (2 x Ball joint fixing, Ball joint strain relief, Feedback system, System holder) - Tool-end clamp - End sleeve - Cable puller - Installation instructions	
Simulation Software		RoboDK	RoboDK Simulation Software	N/A, Download	RoboDK is a powerful and cost-effective simulator and programming tool. No programming skills are required to generate complex robot path. Custom 3D model can be imported to quickly simulate real life application.
Teach Pendant		NexCobot	TP Package-Plug&Play for OM	TP-100-1	A handheld operating teach pendant, well-integrated with OMRON TM Robot. Features an ergonomic housing with safety elements, 10.1 inch WXGA resolution panel and multi-touch p-cap.

Manufacturer SKU numbers are 3rd party part numbers, not OMRON part numbers.

## Related Manuals

Cat. No.	Title
I623	TM5 Regular Payload Series Hardware Installation Manual
I624	TM12 & TM14 Medium & Heavy Payload Series Hardware Installation Manual
I678	TM16 & TM20 Series Hardware Installation Manual
I626	Software Manual TMflow
I627	Software Manual TMvision
I628	TM Mobile Work Station Manual
I629	TM Robot Stand Manual
I630	Pneumatic Control Box Manual
I648	Safety Manual
I662	TM Operator Platform Manual
I664	TM Script Language Manual
I848	Expression Editor and Listen Node Reference Guide
I853	TM Conveyor Tracking Manual

# Terms and Conditions Agreement

## **Read and understand this catalog.**

Please read and understand this catalog before purchasing the products. Please consult your OMRON representative if you have any questions or comments.

## **Warranties.**

- (a) Exclusive Warranty. Omron's exclusive warranty is that the Products will be free from defects in materials and workmanship for a period of twelve months from the date of sale by Omron (or such other period expressed in writing by Omron). Omron disclaims all other warranties, express or implied.
- (b) Limitations. OMRON MAKES NO WARRANTY OR REPRESENTATION, EXPRESS OR IMPLIED, ABOUT NON-INFRINGEMENT, MERCHANTABILITY OR FITNESS FOR A PARTICULAR PURPOSE OF THE PRODUCTS. BUYER ACKNOWLEDGES THAT IT ALONE HAS DETERMINED THAT THE PRODUCTS WILL SUITABLY MEET THE REQUIREMENTS OF THEIR INTENDED USE.

Omron further disclaims all warranties and responsibility of any type for claims or expenses based on infringement by the Products or otherwise of any intellectual property right. (c) Buyer Remedy. Omron's sole obligation hereunder shall be, at Omron's election, to (i) replace (in the form originally shipped with Buyer responsible for labor charges for removal or replacement thereof) the non-complying Product, (ii) repair the non-complying Product, or (iii) repay or credit Buyer an amount equal to the purchase price of the non-complying Product; provided that in no event shall Omron be responsible for warranty, repair, indemnity or any other claims or expenses regarding the Products unless Omron's analysis confirms that the Products were properly handled, stored, installed and maintained and not subject to contamination, abuse, misuse or inappropriate modification. Return of any Products by Buyer must be approved in writing by Omron before shipment. Omron Companies shall not be liable for the suitability or unsuitability or the results from the use of Products in combination with any electrical or electronic components, circuits, system assemblies or any other materials or substances or environments. Any advice, recommendations or information given orally or in writing, are not to be construed as an amendment or addition to the above warranty.

See <http://www.omron.com/global/> or contact your Omron representative for published information.

## **Limitation on Liability; Etc.**

OMRON COMPANIES SHALL NOT BE LIABLE FOR SPECIAL, INDIRECT, INCIDENTAL, OR CONSEQUENTIAL DAMAGES, LOSS OF PROFITS OR PRODUCTION OR COMMERCIAL LOSS IN ANY WAY CONNECTED WITH THE PRODUCTS, WHETHER SUCH CLAIM IS BASED IN CONTRACT, WARRANTY, NEGLIGENCE OR STRICT LIABILITY.

Further, in no event shall liability of Omron Companies exceed the individual price of the Product on which liability is asserted.

## **Suitability of Use.**

Omron Companies shall not be responsible for conformity with any standards, codes or regulations which apply to the combination of the Product in the Buyer's application or use of the Product. At Buyer's request, Omron will provide applicable third party certification documents identifying ratings and limitations of use which apply to the Product. This information by itself is not sufficient for a complete determination of the suitability of the Product in combination with the end product, machine, system, or other application or use. Buyer shall be solely responsible for determining appropriateness of the particular Product with respect to Buyer's application, product or system. Buyer shall take application responsibility in all cases.

NEVER USE THE PRODUCT FOR AN APPLICATION INVOLVING SERIOUS RISK TO LIFE OR PROPERTY OR IN LARGE QUANTITIES WITHOUT ENSURING THAT THE SYSTEM AS A WHOLE HAS BEEN DESIGNED TO ADDRESS THE RISKS, AND THAT THE OMRON PRODUCT(S) IS PROPERLY RATED AND INSTALLED FOR THE INTENDED USE WITHIN THE OVERALL EQUIPMENT OR SYSTEM.

## **Programmable Products.**

Omron Companies shall not be responsible for the user's programming of a programmable Product, or any consequence thereof.

## **Performance Data.**

Data presented in Omron Company websites, catalogs and other materials is provided as a guide for the user in determining suitability and does not constitute a warranty. It may represent the result of Omron's test conditions, and the user must correlate it to actual application requirements. Actual performance is subject to the Omron's Warranty and Limitations of Liability.

## **Change in Specifications.**

Product specifications and accessories may be changed at any time based on improvements and other reasons. It is our practice to change part numbers when published ratings or features are changed, or when significant construction changes are made. However, some specifications of the Product may be changed without any notice. When in doubt, special part numbers may be assigned to fix or establish key specifications for your application. Please consult with your Omron's representative at any time to confirm actual specifications of purchased Product.

## **Errors and Omissions.**

Information presented by Omron Companies has been checked and is believed to be accurate; however, no responsibility is assumed for clerical, typographical or proofreading errors or omissions.

